

RF TEST ENCLOSURE

RT-3140

DATA SHEET



1. Main features

RT-3140 RF Test Enclosure supports broad band testing frequency and provides optimal testing condition to test mobile device.

- Outstanding durability
- Convenient use and maintenance.
- Supports 2x I/O interface panel (IA-series)
- High performance RF absorber on inside walls
- High shielding effectiveness using double layer gasket structure.
- Reliable test result and repeatability
- Fixture mounting holes in the top, bottom and side walls

2 . Product specification

	W (mm)	D (mm)	H (mm)
Outer Size (Closed)	954	801	493
Outer Size (Opened)	954	727	850
Inner Size	843	650	351
Weight	Approx. 52Kg		
Packing Size	1100	950	600
Packing Weight	Approx. 66Kg		
Interface	I/O Panel : IA-Series		

Shielding effectiveness

Frequency – Unit : MHz	Shielding effectiveness – Unit : dB
100-3000	>80
3000-6000	>70
6000-18000 (optional)	>70

The shielding effectiveness in the above is measured when the blank I/O panel is attached.

3. Dimensions

Outside Dimensions

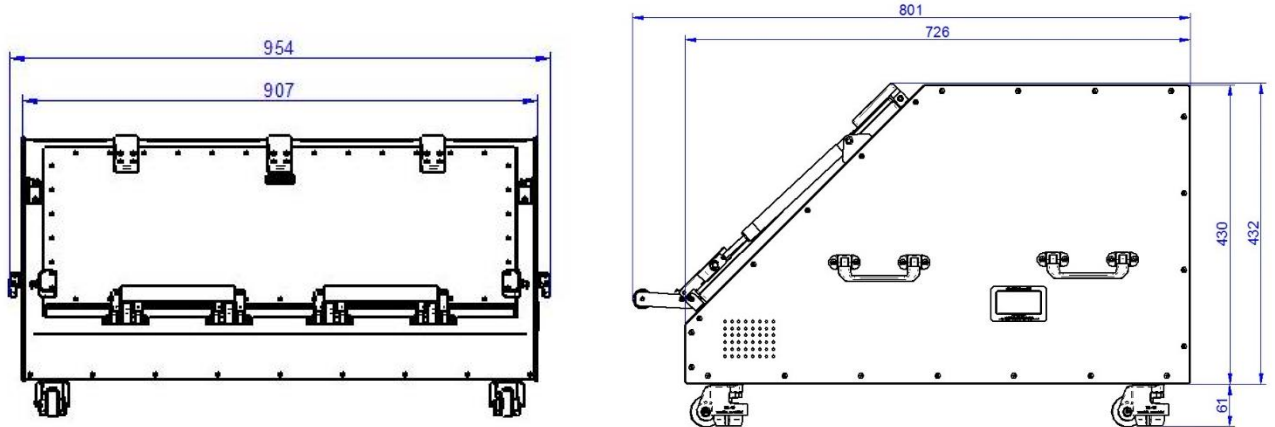

CLOSED

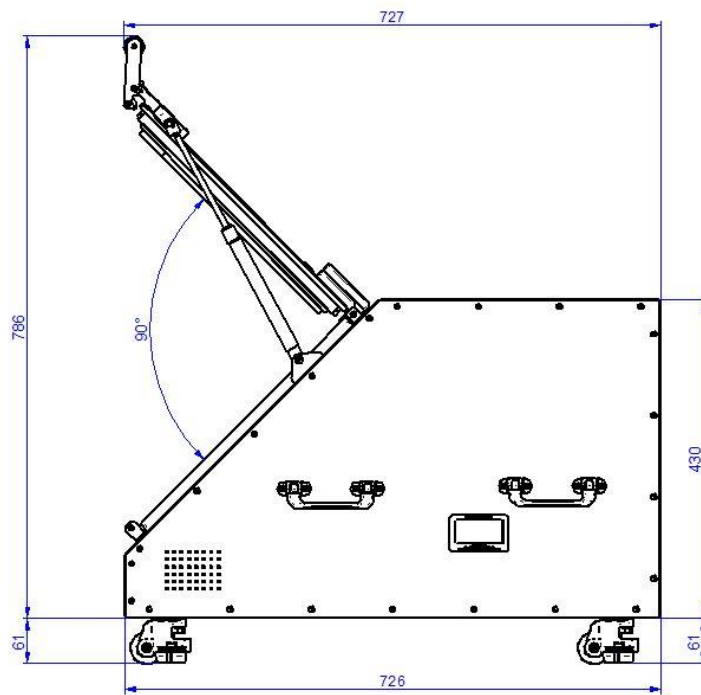

OPENED

Inside Dimensions

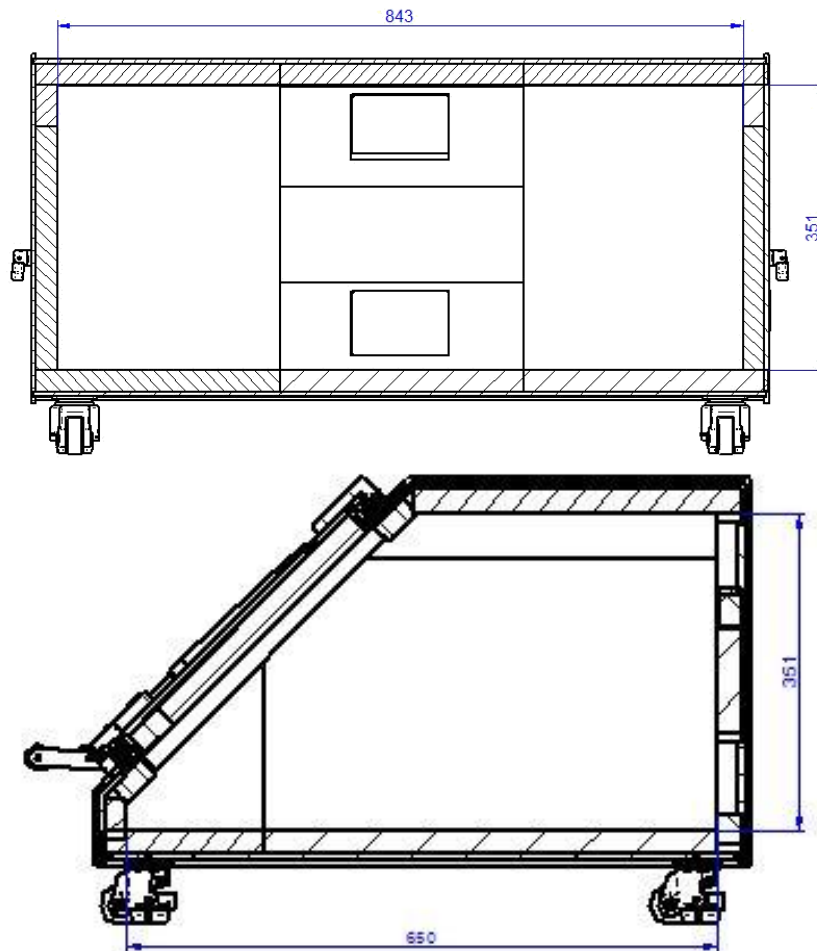

Roottek.co.kr

TEL: +82-70-5138-0370

FAX: +82-31-927-9201

e-mail: roottek@roottek.co.kr

** Specification of chamber can be updated without prior notice **